



## Features

- Single axis measurement, range  $\pm 180^\circ$
- High resolution and accuracy
- Low temperature drift, with optional temperature compensation to further improve temperature performance.
- RS232 or multi-drop RS485 interface with ModBus protocol
- Tough sealed anodised aluminium housing (IP67)
- CE certified and RoHS compliant.
- Braided screen 4 core 3m PUR cable
- Low cost relative to performance
- Small size, 75 x 37.5 x 13.5mm and light weight



## Description

The SOLAR-360 inclinometers are range of high performance low cost single axis tilt sensors for measurement of angle throughout the full 360° range. Through a flexible configuration and calibration program we can supply this device compensated for any specific operating temperature range. The housing is a small, low profile Aluminium housing, hermetically sealed to IP67. The cable is a shielded black PUR cable and is suitable for continuous outdoor use. They utilise a very high performance MEMS sensor which exhibits low long term

drift compared with many competitive devices. Originally designed for use in concentrating Solar Trackers, they can also be used in a wide range of other applications. It has an RS232 and RS485 interface option with our standard communication protocol as well as a version with RS485 multi drop ModBus communication protocol. They are CE and RoHS certified, and are manufactured, calibrated and tested in our UK factory to guarantee performance to the stated specification.

## General Specifications

Parameter	Value	Unit	Notes
<b>Supply Voltage</b> RS232 Version RS485 Version	9-30 12-30	V dc V dc	Supply is filtered, suppressed and regulated internally, however we recommend the use of a low noise supply to prevent noise coupling to the sensor. Minimum supply of 12V is needed for RS485 version where terminating resistors are used.
<b>Operating Current</b>	20	mA	Maximum value at any operating voltage in range without RS485 terminating resistors.
<b>Operating Current</b>	80	mA	Maximum value when driving RS485 with 120Ω terminators
<b>Operating Temperature</b>	-40 to 85	°C	Maximum operating temperature range. Units can be calibrated between -20 and 70°C on request.
<b>RS232/485 Output Rate</b>	38400	bps	Bit rate is adjustable between 115.2k, 57.6k, 38.4k, 19.2k, 9.6k, 4.8k and 2.4k via the digital interface
<b>RS232 Data Format</b>	38.4, 8,1,N		1 start bit, 8 data bits, 1 stop bit, no parity
<b>R485 ModBus Format</b>	38.4, 8,1,N		1 start bit, 8 data bits, 1 stop bit, no parity
<b>Frequency Response</b>	1	Hz	This is the frequency at which the output is 3dB less than the input value. This is adjustable between 8Hz and 0.125Hz via the RS232/485 control commands
<b>Mechanical shock</b>	5000	G	Shock survival limit for internal sensor 5000G for 0.5ms
<b>Weight</b>	45	g	Not including cable
<b>Cable</b>	3	m	4 Core braided screen cable with black PUR jacket
<b>Sealing</b>	IP67	-	Seal rating applies to housing and cable gland. Gland is not designed for flexible cable installation, as this may compromise seal rating



## Performance Specifications

Parameter	SOLAR-360	Unit
Measuring range	±180	°
Zero Bias Error	±0.05	°
Accuracy (@20°C)	±0.07	°
<b>Temperature Errors (without compensation)</b>		
Zero Drift	±0.008	°/°C
Sensitivity Drift	±0.014	%/°C
<b>Temperature Errors (with compensation)</b>		
Zero Drift	±0.002	°/°C
Sensitivity Drift	±0.005	%/°C
<b>Accuracy -10 to 60°C (without compensation)</b>	±0.4	°
<b>Accuracy -10 to 60°C (with compensation)</b>	±0.1	°
<b>Long Term Stability</b>	±0.02	°
<b>Resolution (@1Hz BW)</b>	0.002	°

Parameter	Notes
<b>Measuring range</b>	Defines the calibrated measurement range. Direction of measurement can be reversed and zero position can be reset anywhere in range. Settings are stored in non volatile memory so are remembered after power down.
<b>Zero Bias Error</b>	This is the <b>maximum</b> angle from the device when it is placed on a perfectly level surface. The zero bias error can be removed from measurement errors either by mechanical adjustment, or as a fixed offset value after installation, or by using the 'setzcur' command to zero the device (see page 8)
<b>Accuracy (@20°C)</b>	This is the <b>maximum</b> error between the measured and displayed value at any point in the measurement range when the device is at room temperature (20°C). This value includes cross axis errors.
<b>Temperature Errors</b>	Temperature errors come in two forms, zero drift and sensitivity drift. These values show the maximum errors for standard and compensated devices.
Zero Drift	If the device is mounted to a level surface in the zero position, this value is the <b>maximum</b> drift of the output angle per °C change in temperature.
Sensitivity Drift	When the temperature changes there is a change in sensitivity of the sensor's output. The error this causes in the measurement is calculated from the formula: <b><math>E_{sd} = SD \times \Delta T \times \theta</math></b> Where: <b><math>E_{sd}</math></b> is the change in output (in degrees) due to sensitivity temperature change <b><math>SD</math></b> is the sensitivity drift specification from the above table (0.003%) <b><math>\Delta T</math></b> is the change in temperature in °C <b><math>\theta</math></b> is the current angle of the inclinometer axis in question in degrees.
<b>Accuracy -10 to 60°C (without compensation)</b>	This is the <b>maximum</b> error between the measured and displayed value at any point in the measurement range at any temperature over the specified temperature range without individual temperature compensation.
<b>Accuracy -10 to 60°C (with compensation)</b>	This is the <b>maximum</b> error between the measured and displayed value at any point in the measurement range at any temperature over the calibrated temperature range with individual temperature compensation.
<b>Long Term Stability</b>	Stability depends on environment (temperature, shock, vibration and power supply). This figure is based on being powered continuously in an ideal environment.
<b>Resolution (@1Hz bandwidth)</b>	Resolution is the smallest measurable change in output.



Housing Drawing

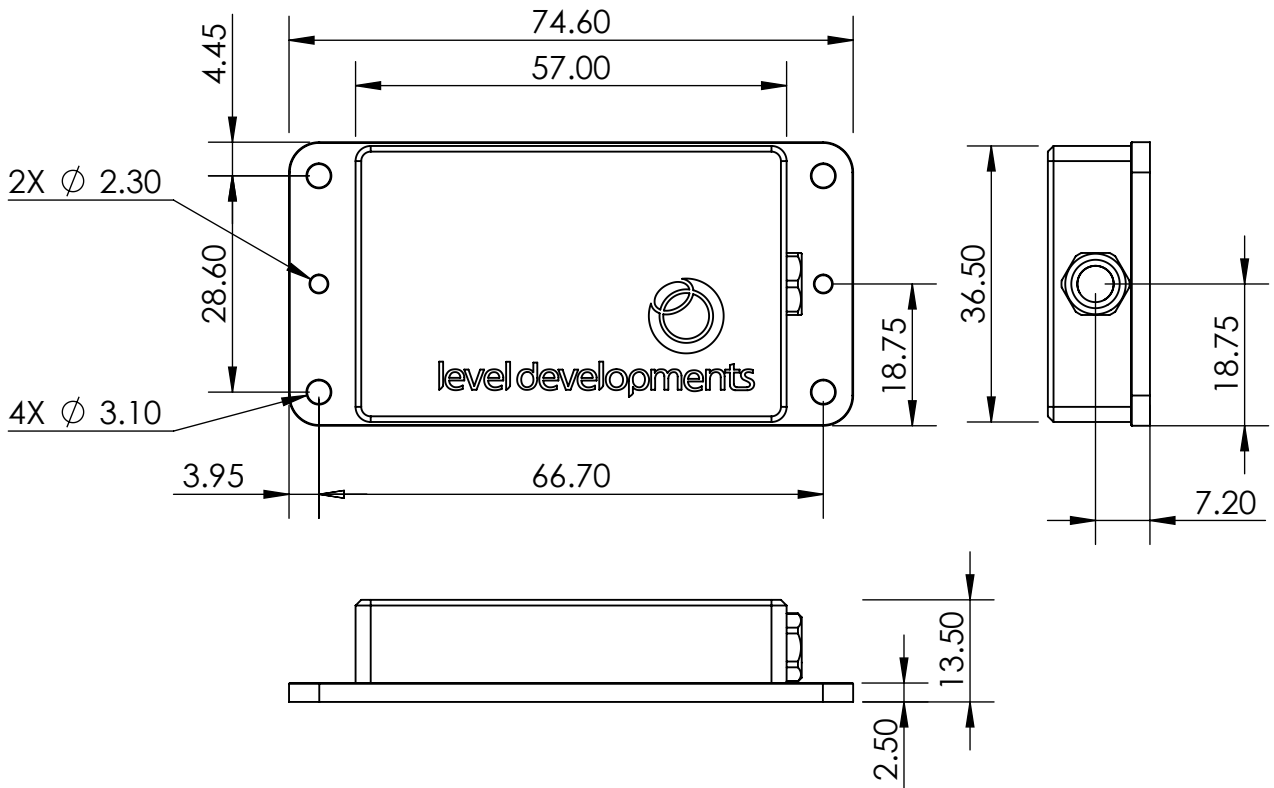

Axis Direction and Mounting Orientation and Wiring Details

Mounted on Vertical Surface

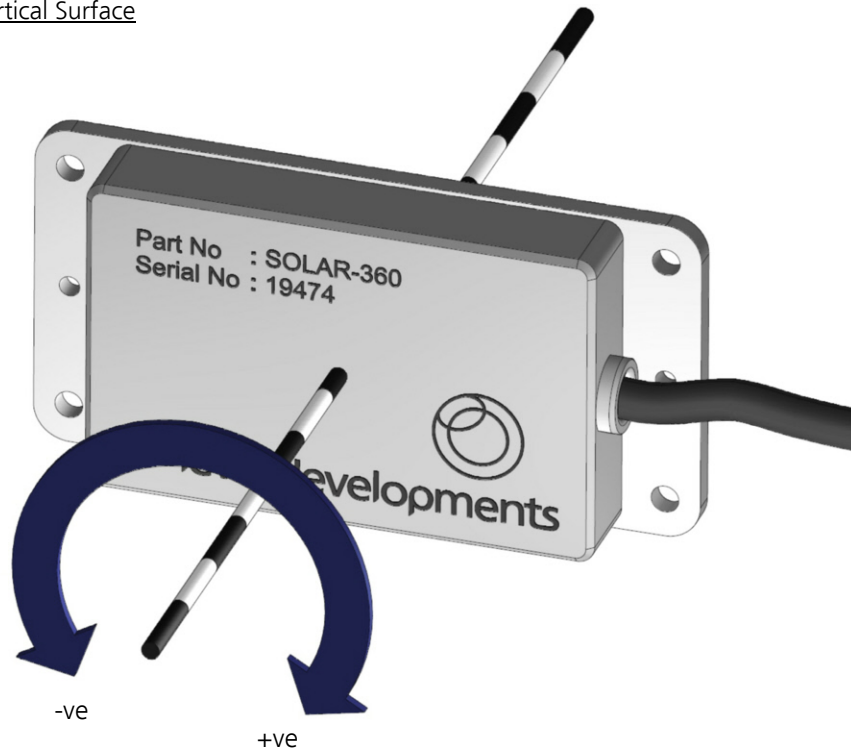

**Cable Details**

1. Core wires, tin plated copper, 18x0.1mm strands per conductor (26 AWG).
2. 4 conductors, colours red, blue, yellow and green. PVC core insulation.
3. Braided screen of tin copper wire with minimum 85% coverage.
4. Black PUR Solar jacket. Flame retardant, reduced smoke generation, zero halogen, excellent for use in water and oil, good for use in acids and fuels, radiation tolerance: 10E6 Gy, UV stable, suitable for continuous outdoor use.

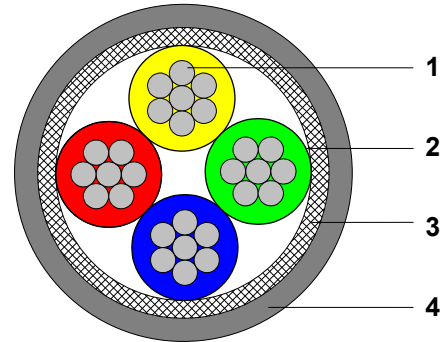

Wire Colour	RS232 Version	RS485 Version
Red	+ve Supply	+ve Supply
Blue	Ground	Ground
Yellow	RS232 Txd	RS485 -
Green	RS232 Rxd	RS485 +

Parameter	Value	Unit	Notes
Approximate Weight	40	g/m	
Operating Temperature	-20 to 70	°C	
Conductor Resistance	100	Ω/Km	Maximum resistance
Insulation Resistance	1500	MΩ/Km	Minimum resistance
Test Voltage	1	KV DC	
Voltage Rating	250	V	
Core Current Rating	0.5	A	At 40°C air temperature
Individual Core Diameter	1.1	mm	
Overall Diameter	4.5	mm	

**Certification**

The products are type approved to in accordance with the following directive(s):

EMC Directive 2004/108/EC

And it has been designed, manufactured and tested to the following specifications:

BS EN61326-1:2006

Electrical equipment for measurement, control and laboratory use – EMC Requirements

BS EN55011:2007, Group 1  
Class B

Certification is available on request.





Part Numbering

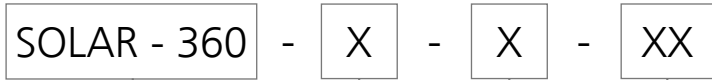

Series Prefix

- 1 - No additional temperature compensation
- 2 - Temperature compensation over -10 to 60°C

- RS232 - RS232 Interface with LD standard communication protocol
- RS485 - RS485 Interface with LD standard communication protocol
- RS485M - RS485 Interface with ModBus communication protocol

Customer Specific Options (Optional)

Example:

**SOLAR-360-2-RS485M**

SOLAR-360 Series dual axis inclinometer  
±180° Full Scale Measurement Range  
Temperature compensated over the range -10 to 60°C  
RS485 Interface with ModBus communication protocol



## Level Developments Simplified Control Command Set

Data is transmitted and received over RS232 in full duplex mode and for RS485 versions in half duplex mode. The default configuration is with the baud rate set to 38.4kbps, with 8 data bits, 1 stop bit and no parity. All commands are lower case and 7 bytes long. The time between each character of the command must be less than 100ms otherwise the device will discard the command. The settings are all stored in non volatile memory.

Command	Description	Response Length	Response
get-360	Returns the angle as either: - An INT32 value equal to the angle x 1000 - A fixed length ASCII string terminated with a carriage return depending on the setting of commands 'setoasc' or 'setoint' Shipping default is INT32.	4 bytes 9 bytes	0x XX XX XX XX +025.430<CR>
gettemp	Returns the temperature of the sensor as either: - An INT16 value equal to the temperature x 100 - A fixed length ASCII string terminated with a carriage return depending on the setting of commands 'setoasc' or 'setoint' Shipping default is INT32.	2 bytes 6 bytes	0x XX XX ±tt.t<CR>
str9999	Set continuous output transmission rate in milliseconds (50-9999ms) - str0100 - 100ms (0.1s) between transmissions - str8500 - 8500ms (8.5s) between transmissions	2 bytes	OK
setcasc	Sets the output to transmit the angle continuously in ASCII format at the rate defined by strXXXX.	9 bytes	+025.430<CR>
stpcasc	Stops the continuous transmission of ASCII data	2 bytes	OK
get-flt	Returns the value of the current filter time constant in ms as an INT16	2 bytes	0x XX XX
setdir5 setdir6	Sets the measurement direction to positive clockwise Sets measurement direction to negative clockwise	2 bytes	OK
setzcur	Tare function to set the current position to zero	2 bytes	OK
setzfac	Cancel tare function and resets zero to factory setting	2 bytes	OK
setoasc	Sets the output to ASCII format	2 bytes	OK
setoint	Sets the output to Integer format	2 bytes	OK
setflt1 setflt2 setflt3 setflt4 setflt5 setflt6 setflt7	Sets the digital filter frequency response to 0.125Hz Sets the digital filter frequency response to 0.25Hz Sets the digital filter frequency response to 0.5Hz Sets the digital filter frequency response to 1Hz Sets the digital filter frequency response to 2Hz Sets the digital filter frequency response to 4Hz Sets the digital filter frequency response to 8Hz	2 bytes	OK
set-br1 set-br2 set-br3 set-br4 set-br5 set-br6 set-br7	Sets the BAUD rate to 2400bps Sets the BAUD rate to 4800bps Sets the BAUD rate to 9600bps Sets the BAUD rate to 19200bps Sets the BAUD rate to 38400bps Sets the BAUD rate to 57600bps Sets the BAUD rate to 115200bps	2 bytes	OK
setter0 setter1	Disable 120Ω RS485 terminating resistor (default) Enable 120Ω RS485 terminating resistor	2 bytes	OK



### Software

A free Windows based application for reading angle, logging and device configuration is available from our website. It requires Windows XP SP3, Windows 7 or Windows 8, and works with 32 and 64 bit systems. It also requires the .net framework V3.5 or higher, and will prompt you to download and install this from Microsoft if it is not already installed on your system. A COM port is also required, and can either be a built in COM port, or a USB to Serial COM port.

The basic features are shown below:

- Automatic or manual configuration of COM port parameters
- Compatible with single or dual axis sensors
- Adjustable number of decimal places on displays
- Logging of data at specified intervals into CSV file
- Setting device to absolute or relative measurement mode
- Switching the data transfer protocol between Integer and ASCII
- Changing the frequency response of the sensor
- Changing the Baud rate of the sensor

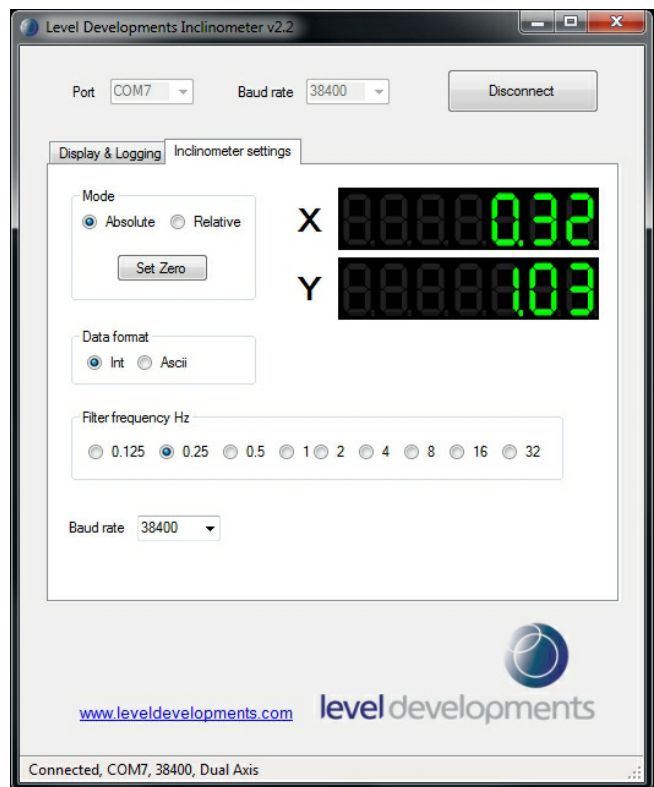
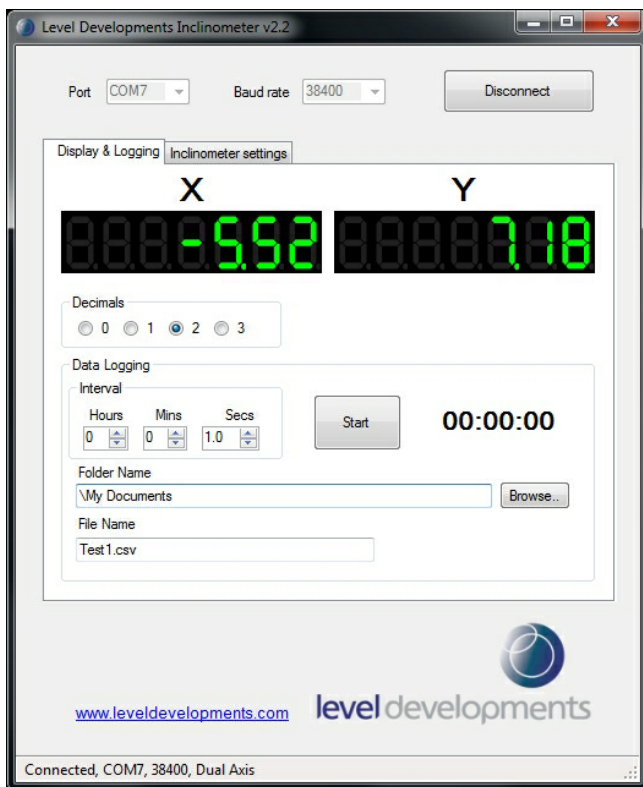

We can also offer custom software development services, please contact us for further information.

**This software is provided 'as-is', without any express or implied warranty. In no event will the authors be held liable for any damages arising from the use of this software.**





## ModBus Control Command Set

Data is transmitted and received over RS485 in half duplex mode using the ModBus RTU protocol. The following section provides some basic information about the serial communication between the host PC or PLC and the SOLAR-2. The full ModBus specification can be obtained from <http://www.modbus.org>. ModBus is a command/response protocol over a serial bus.

The default ModBus serial parameters are: 38400 baud, 1 start bit, 8 data bits, no parity and 1 stop bit. The 8 data bits are sent LSB first. The baud rate can be changed to 115200, 57600, 38400, 19200, 9600, 4800 or 2400 by sending the appropriate command.

The byte order for all 16-bit values is Big Endian (most significant byte first).

Read and write access to the SOLAR-2 is done using ModBus Function Code 3 (read holding registers) and ModBus Function Code 6 (write single register) commands. These two function codes provide the basic functionality needed by most users of the SOLAR-2. A user defined ModBus function code 110 is provided for less commonly used, off-line functions such as setting serial port parameters and changing the device address.

ModBus device address must be in the range 1 to 247. All devices are shipped with a default address of 100 (decimal). Address 0 is the ModBus broadcast address. With this address all devices will perform the action of the function code. The maximum number of these devices that can be connected on a single network is 128.

All ModBus commands and responses have a 16-bit CRC for error detection.

ModBus RTU data is in binary format rather than ASCII, so it cannot be viewed properly on a text terminal.

Below is a list of the register locations for reading and writing:

## ModBus Registers

Parameter	Address	ModBus Register Address	Description	Read/Write
Angle	0x04	40,005	Address 0x04 returns the upper 16 bits of the sensor angle. This combines with address 0x05 to form a 32 bit signed integer value equal to the measured angle x 1000.	Read Only
	0x05	40,006		
Sensor Temperature	0x06	40,007	Returns a 16 bit signed integer value equal to the temperature of the sensor in degrees Celcius x 100	Read Only
Sensor Filter Index	0x09	40,010	Returns a 16 bit integer value between 1 and 7 which relates to a table of filter responses from 0.125 to 8Hz	Read / Write
Tare Function	0x14	40,021	When set to '1' the device is zeroed at the current position (relative mode). When set to '0' the device is returned to absolute measurement mode (tare cancelled)	Read / Write
RS485 Termination Resistor	0x15	40,022	When set to '0' the termination resistors are disabled (default mode). When set to '1' the termination resistors are enabled across the RS485 A and B data-lines.	Read / Write





**Frequency Response Filter Indexes**

The frequency response of the sensor can be changed to any of the response times shown in the table. The filter is a 2nd order Besel low pass filter implemented in a FIR algorithm.

The sensor has a built in mechanical filter at 18Hz and an electronic filter with a 8Hz cutoff frequency, so specifying a filter frequency above this value will not increase the response beyond this amount.

Filter Index	Freq. Response (Hz)	Damping Time (ms)
1	0.125	8000
2	0.25	4000
3	0.5	2000
4	1	1000
5	2	500
6	4	250
7	8	125

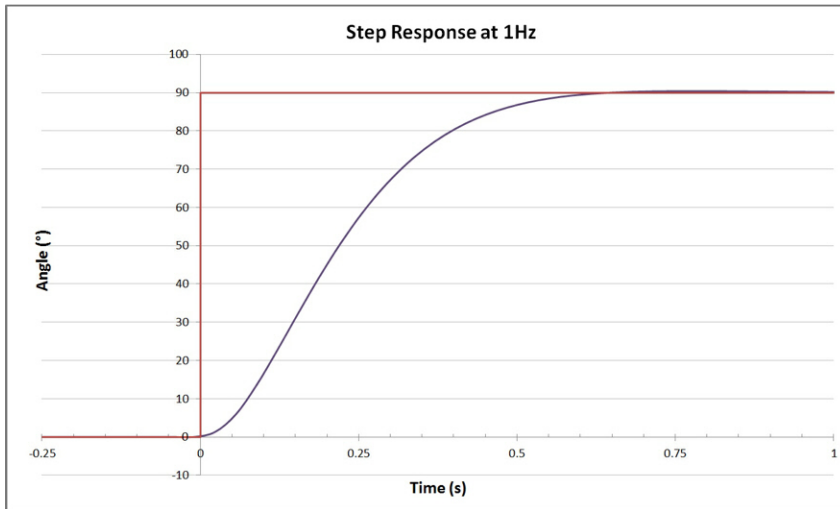

**Reading a Holding Register**

The data from the device is stored in holding registers as detailed on page 4. Function code 0x03 is used to read these registers. Below is the command and response message format, including the error response in the even there is an error.

	Byte Data	No Of Bytes	Description
Command	0x64	1	Slave address 100
	0x03	1	Function code for read register
	0x0004	2	Starting register (0x0004 is angle)
	0x0002	2	Number of registers to read
	0x8C3F	2	CRC-16 of all bytes
Response	0x64	1	Slave address 100
	0x03	1	Function code for read register
	0x04	1	Byte count (2 x number of registers)
	0x0000	2	First and second register data : 0x0000A69C = 42652 (decimal) = 42.652°
	0xA69C	2	
	0xB4FC	2	CRC-16 of all bytes
Error Response	0x64	1	Slave address 100
	0x83	1	ModBus error function code
	0x01	1	Exception Code (0x01 invalid function code, 0x02 invalid register address)
	0x90EF	2	CRC-16 of all bytes

**Writing to a Holding Register**

Data can be written to some registers, such as the registers that store the filter indexes for each axis frequency response. Function code 0x06 is used to write these registers as detailed below.

	Byte Data	No Of Bytes	Description
Command	0x64	1	Slave address 100
	0x06	1	Function code for write register
	0x0009	2	Register to write (0x0009 is axis filter)
	0x0003	2	Data to write (16 bit). 0x0003 = 0.5Hz
	0x103C	2	CRC-16 of all bytes
Response (same as command)	0x64	1	Slave address 100
	0x06	1	Function code for write register
	0x0009	2	Register to write (0x0009 is axis filter)
	0x0003	2	Data to write (16 bit). 0x0003 = 0.5Hz
	0x103C	2	CRC-16 of all bytes
Error Response	0x64	1	Slave address 100
	0x83	1	ModBus error function code
	0x01	1	Exception Code (0x01 invalid function code, 0x02 invalid register address)
	0x90EF	2	CRC-16 of all bytes

**Changing the BAUD Rate**

The BAUD rate of the device can be changed using the special function code 0x6E and special command code 0x8F. The reply is sent at the original BAUD rate, the device BAUD rate is only updated to the new setting after a 250ms delay:

	Byte Data	No Of Bytes	Description
Command	0x64	1	Slave address 100
	0x6E	1	Function code - 0x6E
	0x8F	1	LD command - 0x8F = set baud
	0x03	1	1 = 2400
			2 = 4800
			3 = 9600
			4 = 19200
			5 = 38400
			6 = 57600
7 = 115200			
0x5AF8	2	CRC-16 of all bytes	
Response	0x64	1	Slave address 100
	0x6E	1	Function code - 0x6e
	0x8F	1	LD command - 0x8F = set baud
	0x00	1	0 = success, 1 = failed
	0x1AF9	2	CRC-16 of all bytes



## Changing the Device Address

The Address of the device can be changed using the special function code 0x6E and special command code 0x91. The device will reply with the original address in the response, and will change internally after the response has been sent.

	Byte Data	No Of Bytes	Description
Command	0x64	1	Slave address 100
	0x6E	1	Function code - 0x6e
	0x91	1	LD command - 0x91 = change address
	0x01	1	New Address = 1
	0xD299	2	CRC-16 of all bytes
Response	0x64	1	Slave address 100
	0x6E	1	Function code - 0x6e
	0x91	1	LD command - 0x91 = change address
	0x00	1	0 = success 1 = failed
	0x1359	2	CRC-16 of all bytes

## Examples of Reading Angle

### Example 1: Read the angle from the sensor with address 100 (0x64):

#### Command

```

address (0x64 = 100 decimal)
| function code
| | starting reg. to read (0x0004)
| | | number of reg. to read (0x0002)
| | | |
| | | | CRC-16
| | | |
64 03 00 04 00 02 8c 3f

```

#### Response (positive angle)

```

address (0x64 = 100 decimal)
| function code
| | byte count
| | | angle (0x0000a69c = 42652 decimal = 42.652 degrees)
| | | |
| | | | CRC-16
| | | |
64 03 04 00 00 a6 9c b4 fc

```

#### Response (negative angle)

```

address (0x64 = 100 decimal)
| function code
| | byte count
| | | angle (0xffffda7d7 = -153641 decimal (-153.641 degrees))
| | | |
| | | | CRC-16
| | | |
64 03 04 ff fd a7 d7 54 bf

```



**Example 2: Change the frequency response to 0.5Hz:**

Command

```

address (0x64 = 100 decimal)
| function code
| | register to write to (0x0009)
| | | data to write (0x0003 = 0.5Hz)
| | | |
| | | | CRC-16
| | | | |
64 06 00 09 00 03 10 3c

```

Response

```

address (0x64 = 100 decimal)
| function code
| | register written to (0x0009)
| | | data written (0x0003 = 0.5Hz)
| | | |
| | | | CRC-16
| | | | |
64 06 00 09 00 03 10 3c

```

**Example 3: Change the device address from 100 to 1:**

Command

```

address (0x64 = 100 decimal)
| special function code
| | LD command for change address
| | | new address (0x01)
| | | |
| | | | CRC-16
| | | | |
64 6e 91 01 d2 99

```

Response

```

address (0x64 = 100 decimal)
| special function code
| | LD command for change address
| | | Success/Fail (0x00 = success)
| | | |
| | | | CRC-16
| | | | |
64 6e 91 00 13 59

```



**Example 4: Setting the tare function (current position to zero):**

**Command**

```
address (0x64 = 100 decimal)
| function code
| | register to write to (0x0014)
| | | data to write (0x0001 = set tare on)
| | | |
| | | | CRC-16
| | | |
64 06 00 14 00 01 01 fb
```

**Response**

```
address (0x64 = 100 decimal)
| function code
| | register written to (0x0014)
| | | data written (0x0001 = set tare on)
| | | |
| | | | CRC-16
| | | |
64 06 00 14 00 01 01 fb
```